

EM INDUSTRIAL SUPPLIES

Sofa Mechanism,
Sewing & Cutting
Machines Spare Parts
Supplier

SOUTH AFRICA | UNITED KINGDOM | ZIMBABWE



ABOUT OUR COMPANY



EM INDUSTRIAL SUPPLIES (EMIS)

Sofa Mechanism, Sewing & Cutting Machine Spares Supplier

Since our founding in 2008, we have built a reputation as an innovative and reliable company in the supply chain industry. Our success is rooted in dedication, determination, and a solid foundation across several key sectors.

One of our core divisions is EM Industrial Supplies (EMIS), where we specialize in Sewing and Cutting Machines, Sofa Mechanism Spares, and EMIS Logistics. Our experienced and professional team collaborates with some of the world's most renowned brands, including Gerber Technology, Groz-Beckert, Pegasus, Bullmer, Pfaff, Lectra, Durkopp Adler, Seiko, Juki, Singer, Kansai, and Mitsubishi.

Over the years, we've expanded our reach to serve clients in numerous countries around the world. Today, we are proud to be recognized as a leading global supplier of Sewing and Cutting Machine Spares.

OUR BRANCHES

64 Shetland Drive Queens Park Bulawayo Zimbabwe	2 Premier Place Industrial Park Durban, KZN South Africa	Agent Kumen Naidoo 163 North End Road West Kensington London W14 9NH Kumen@naidoolegal.co.uk	emindustrial@telkomsa.net (+27) 074 918 1839 www.emgroupsa.co.za www.emindustrialsupplies.com
--	---	---	--



Sofa Hinge



EM INDUSTRIAL SUPPLIES

Recliner & Sofa Mechanism Spares Supplier



C-5B-1多级铰



C-51B密封多级铰



C-51F 大静音铰
90° -180° / 90° -190°



C-520 复位大静音铰
90° -180° / 90° -190°

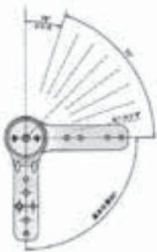

90° -180° 8档

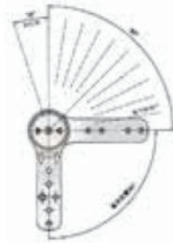

90° -190° 10档



99° -190° 9档



108° -190° 8档

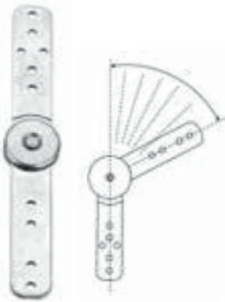

C-510 小静音铰(三档/六档)



C-51Q 加工头枕铰



C-51K 单边滑动铰

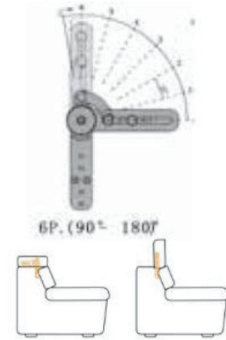

6P. (90° - 180°)



C-51H 双边滑动铰



C-51A 回弹滑动铰





Headrest Ratchet Hinges

EM INDUSTRIAL SUPPLIES

Recliner & Sofa Mechanism Spares Supplier



C-6A-1头枕铰链



C-6A-5头枕铰链



C-6A-6头枕铰链



C-6A-3头枕铰链



C-6A-2五孔头枕铰链



C-6A-2两孔头枕铰链

Headrest Ratchet Hinges



EM INDUSTRIAL SUPPLIES

Recliner & Sofa Mechanism Spares Supplier



C-6A-8头枕铰链



C-6A-9头枕铰链

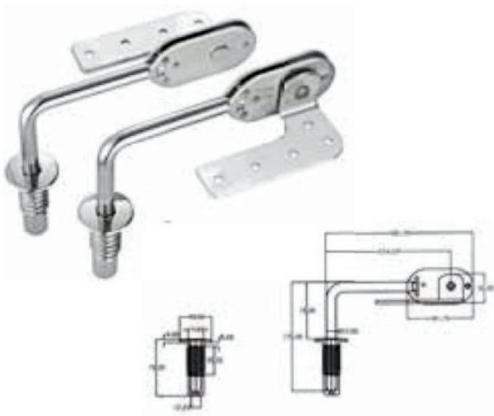

C-6A-7头枕铰链



C-614头枕铰链
Headrest hinge



C-614B 头枕铰链
Headrest hinge

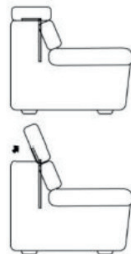

C-614F 头枕铰链

Headrest Ratchet Hinges



EM INDUSTRIAL SUPPLIES

Recliner & Sofa Mechanism Spares Supplier



C-140包边头枕



C-141包边头枕



C-142包边头枕



C-143包边头枕



C-144包边头枕



C-145包边头枕



C-146包边头枕

Headrest Ratchet Hinges



EM INDUSTRIAL SUPPLIES

Recliner & Sofa Mechanism Spares Supplier

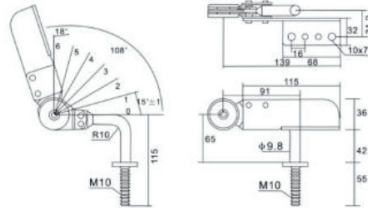

C-308A单边长耳

功能特点 Functional features

使用寿命: 30000次/连续
 表面处理: 光铬蓝锌
 外包装: 37x22x20 (mm) 25对/箱
 重量: 21.2kg/箱

Service life: 30,000 / continuous
 Surface treatment: light chrome blue zinc
 Outer packing: 37x22x20 (mm) 25 pairs/boxes
 Weight: 21.2kg/box

技术参数 Technical parameters

开始度数 Start degree	结束度数 Start	档位 Part No.
90°	180°	12档
90°	165°	10档
90°	150°	8档



C-338A 双耳头枕 三档/六档

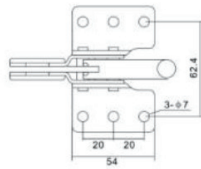

C-338H 双耳头枕



C-338Q 单耳头枕

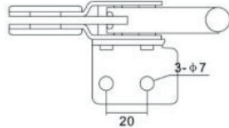

C-338D 单耳头枕

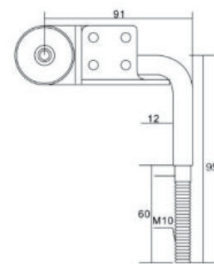
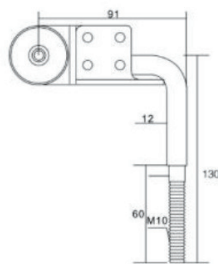
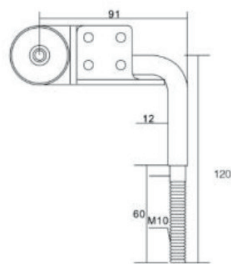
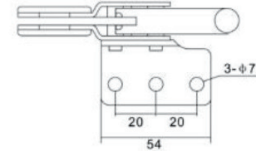

Headrest Ratchet Hinges



EM INDUSTRIAL SUPPLIES

Recliner & Sofa Mechanism Spares Supplier



C-338E 双耳头枕 三档/六档

功能特点 Functional features

使用寿命: 30000次/连续
 表面处理: 光铬蓝锌
 外包装: 37x23x18 (mm) 25对/箱
 重量: 23.7kg/箱

Service life: 30,000 / continuous
 Surface treatment: light chrome blue zinc
 Outer packing: 37x 23x18 (mm) 25 pairs/boxes
 Weight: 23.7 kg/box

技术参数 Technical parameters

开始度数 Start degree	结束度数 Start	档位 Part No.
90°	135°	3档
90°	165°	5档
90°	180°	6档

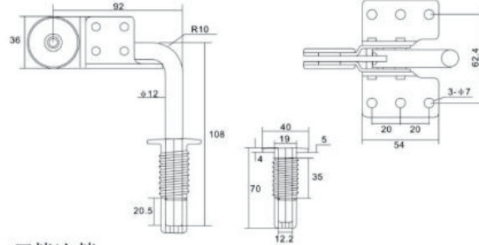

C-308E单边长耳

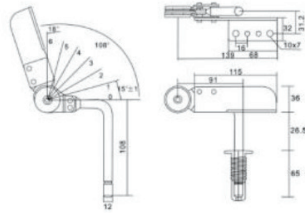

C-338K 双耳头枕



C-338C 单耳头枕

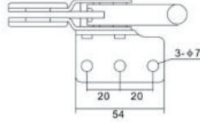

F-202 锌合金套筒

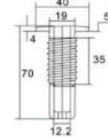

C-338E 双耳头枕



C-338E-2 双耳头枕



C-338E-3 双耳头枕

Headrest Ratchet Hinges



EM INDUSTRIAL SUPPLIES

Recliner & Sofa Mechanism Spares Supplier



C-348B 静音头枕(十二档)

功能特点 Functional features

使用寿命: 30000次连续
 表面处理: 光铬蓝锌
 外包装: 37x22x20 (mm) 25对/箱
 重量: 22.5kg/箱

Service life: 30,000 / continuous
 Surface treatment: light chrome blue zinc
 Outer packing: 37x22x20 (mm) 25 pairs/boxes
 Weight: 22.5 kg/box

技术参数 Technical parameters

开始度数 Start degree	结束度数 Start	档位 Part No.
90°	180°	12档
90°	180°	10档
90°	180°	8档



C-348A 静音头枕(十二档)



C-358A 静音头枕(十二档)



C-358E 静音头枕(十二档)



C-358F 静音双耳头枕



C-620k 滑动铰链



C-620头枕铰链(8档/12档)

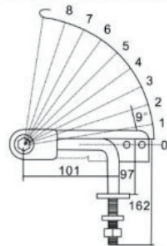

8P(90°-162°)



C-620E头枕铰链

Headrest Ratchet Hinges



EM INDUSTRIAL SUPPLIES

Recliner & Sofa Mechanism Spares Supplier



C-624 静音头枕

HOT

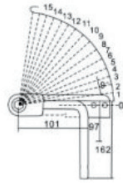

15P(90°-190°)



C-624A



C-701 无档枕头铰



C-313A 沙发头架/Pull up headrest



效果图



C-313B 沙发头架/Pull up headrest



C-75A-1 双杆沙发头枕架(安装片可选向内或向外) Pull up headrest



C-75B-1 单杆沙发头枕架 Pull up headrest



C-75A-2 双杆沙发头枕架(安装片向内)



二孔 四孔

F-212 电镀锌合金盖
Zinc alloy decorative cover



C-75D 银色双杆头枕架

Sofa Comecter Series



EM INDUSTRIAL SUPPLIES

Recliner & Sofa Mechanism Spares Supplier



C-209A沙发连接插件
Sofa Connection buckle



C-209D 沙发连接插件
Sofa Connection buckle



C-209 F 沙发连接件
Sofa Connection buckle



C-209C沙发连接插件
Sofa Connection buckle



沙发连接特征:
设计简单.
适应您沙发的铰截面要求.
品质优异, 终生保修

Sofa Connector features:
Simple design.
Hinged to adapt to your sofa sectional requirements.
Supreme quality, lifetime warranty.



C-209B沙发连接插件
Sofa Connection buckle



C-209 E 加厚塑料连接件
Sofa Connection buckle



C-203连接插扣
Sofa Connection buckle



C-24挂钩插片(金色/黑色)
Sofa Connection buckle



C-214 沙发插片(银白、黑色)
Sofa Connection buckle



C-214E四孔插片



C-214F插片



C-215 连接插片
Sofa Connection buckle



218A连接件



218B连接件

Sofa Comecter Series



EM INDUSTRIAL SUPPLIES

Recliner & Sofa Mechanism Spares Supplier



C-121插扣
Size: L = 95mm



C-122插扣
Size: L = 130mm



C-210长插扣
Size: L = 120mm



C-210A加长插扣
Size: L = 160mm



C-210F大插扣
Size: L = 120/90mm



C-210E长插扣
Size: L = 180mm



C-211插件



C-204A 连接插件



效果图



C-23沙发扣
Sofa Connection buckle



C-204 连接插件



C-625 平移铰 H=14/18cm

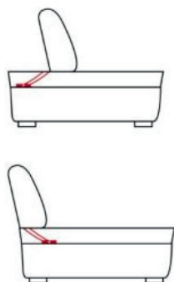
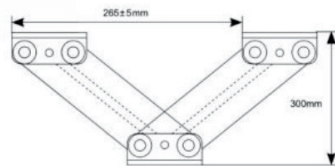

H = 23/28cm
C-615 靠枕铰



C-635 枕铰

Sofa Hinge



EM INDUSTRIAL SUPPLIES

Recliner & Sofa Mechanism Spares Supplier



C-632A 升降锌板架/Headrest lift ratchet hinge

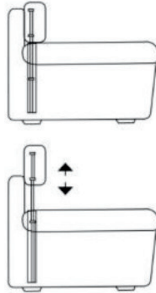

C-632B 升降锌板架
Headrest lift ratchet hinge



C-621 头枕角度调节铰



C-632D 升降架

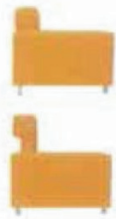

C-253 扶手转盘/ Rotating disc with armrest



C-831 铝合金角调铰链

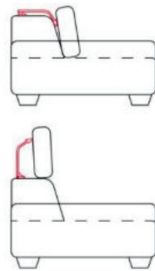

C-832 合金头枕铰



C-626 头枕角度调节铰



C-622 头枕角度调节铰



C-163A 手动座位滑动架



C-163B 电动座位滑动架

Sofa Hinge



EM INDUSTRIAL SUPPLIES

Recliner & Sofa Mechanism Spares Supplier



C-5A反扁铰(扁弹簧)



C-5C反扁铰(圆弹簧)



C-5细扁铰

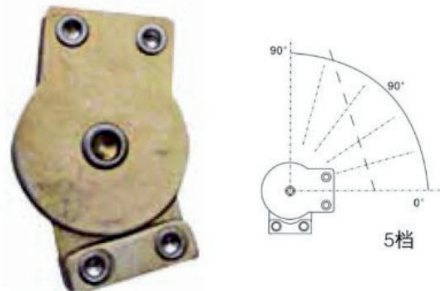

C-26-2B短边反五档千层铰

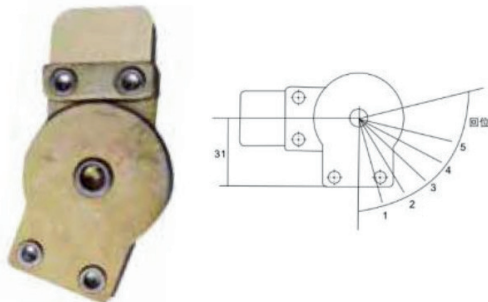

C-26-2D反五档千层铰

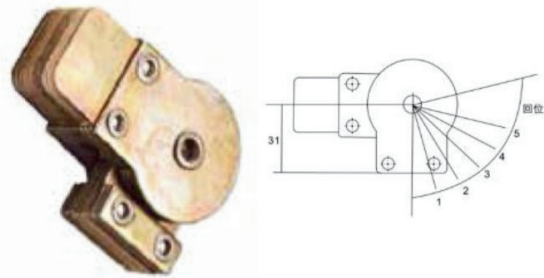

C-26-2A反五档千层铰

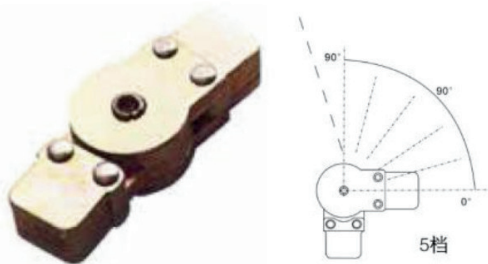

C-26-2C反五档千层铰

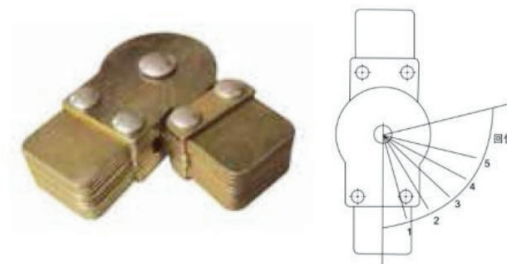

C-26H 正五档千层铰

Sofa Hinge



EM INDUSTRIAL SUPPLIES

Recliner & Sofa Mechanism Spares Supplier



C-213头枕铰链



C-213头枕角码



应用实例



C-213连体角码头枕铰



C-260 不锈钢无档头枕



C-410 无档头枕



C-411 无档头枕



C-407 无档头枕铰

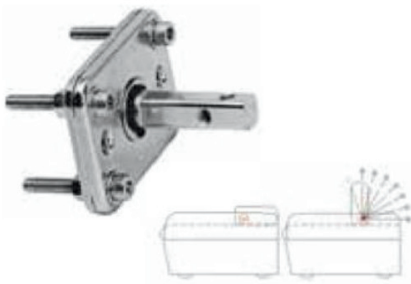

C-633头枕铰



C-263 无档千层铰



C-264 无档千层铰



C-5D-2头枕铰链



Sofa Hinge



EM INDUSTRIAL SUPPLIES

Recliner & Sofa Mechanism Spares Supplier

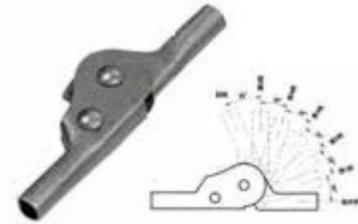

C-216-1正五档90° 日本扣
Single gear wheel hinge

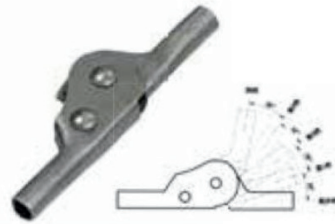

C-216-2正三档 日本扣
Single gear wheel hinge



C-216-3正五档180° 日本扣
Single gear wheel hinge

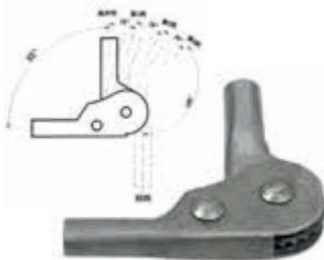

C-216-4反三档日本扣
Flat gear wheel hinge



C-216-5反五档日本扣
Flat gear wheel hinge

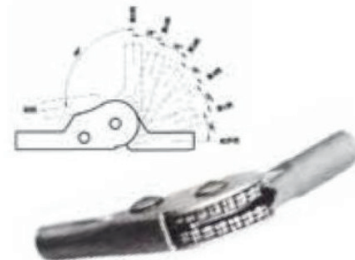

C-216-7双齿日本扣
Double gear wheel hinge

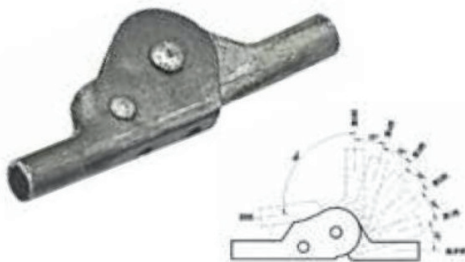

C-216-8带孔正五档180° 日本扣

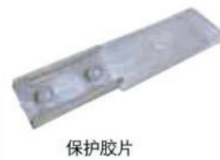

保护胶片



C-236 热处理加硬日本扣 (2.5/3mm厚)
Heat treatment wheel hinge



C-217 三脚日本扣



C-306 无段随意关节



C-303 14档双弹簧带把手关节

Sofa Hinge



EM INDUSTRIAL SUPPLIES

Recliner & Sofa Mechanism Spares Supplier

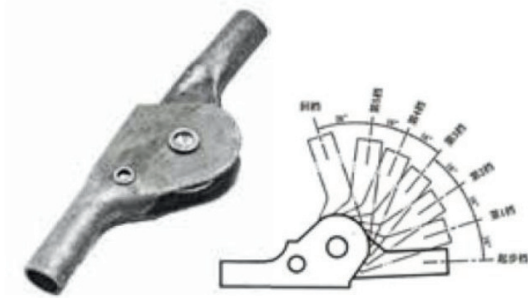

C-28-1正五档90° 大日本扣
Big wheel hinge

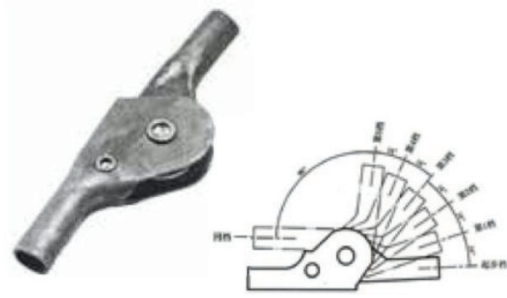

C-28-2正五档180° 大日本扣
Big wheel hinge



C-27-1三档电镀日本扣
Flat gear wheel hinge



C-27-2五档电镀日本扣
Flat gear wheel hinge



C-216-9 无牙日本扣



C-28-3 电镀大日本扣



C-631 休闲架



C-632 休闲架



C-26-1加工日本扣



C-26-3加工日本扣



C-26-5加工日本扣

Sofa Hinge



EM INDUSTRIAL SUPPLIES

Recliner & Sofa Mechanism Spares Supplier



C-78B直铰链



C-78A铰链



C-703 随意停



F46合页



C-79六节带齿铰链



C-79A铰链



C-4档



C-7档



C-10档



C-21一字拉杆
Row multi-level hinge

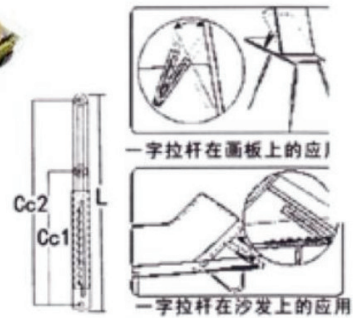

规格	L	Cc1	Cc2
4档	145	120	170
7档	185	165	245
10档	240	215	355



B



C-232人字拉杆



C-22人字拉杆
Multi-level hinge



Sofa Hinge



EM INDUSTRIAL SUPPLIES

Recliner & Sofa Mechanism Spares Supplier



C-583 气动茶几铰



C-003茶几架连接扁铁



C-589 气动茶几铰



C-582气动茶几铰
Tea table support with gas spring mechanism



效果图



C-58茶几架
Rise and fall tea table stand



C-580茶几架 (小号/大号)
Rise and fall tea table stand



C-586 气动茶几铰



C-581 弹簧茶几铰
Rise and fall tea table stand



C-587 弹簧茶几铰
Rise and fall tea table stand



C-588 双开茶几铰

Sofa Hinge



EM INDUSTRIAL SUPPLIES

Recliner & Sofa Mechanism Spares Supplier



C-2二节铰

C-1A钮铰

C-2A弹簧铰

C-3三节铰

C-2B弹簧铰

F-34小撑杆



C-9平面升降器

C-9B

C-7侧面升降器
Height adjustable pillow rod

C-8直杆升降器

C-6C升降器

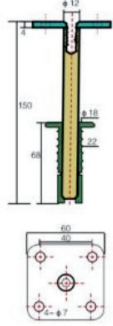

C-9F

C-9A可拆装升降器

C-8A-3 鸡翼升降器

C-8A-2鸡翼

C-8A-1鸡翼

C-8B 弯杆



C-14单弹簧调节器

C-15双弹簧调节器

C-16大调节器

Sofa Hinge



EM INDUSTRIAL SUPPLIES

Recliner & Sofa Mechanism Spares Supplier

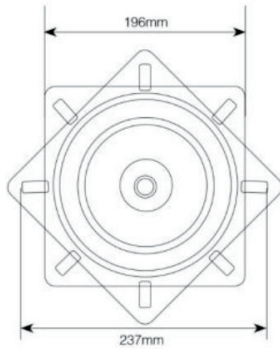
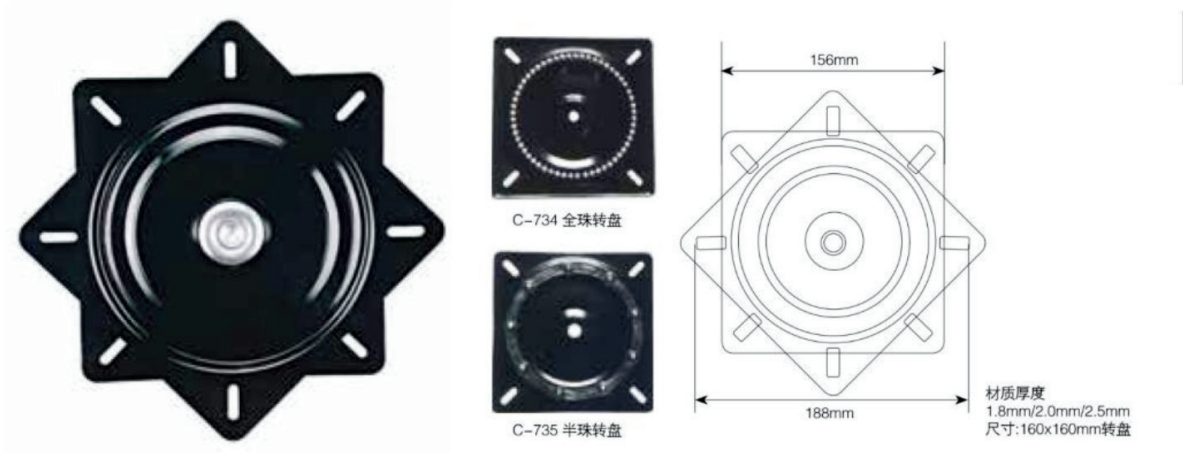

材质厚度: 2.0mm/2.5mm
尺寸:200x200mm转盘

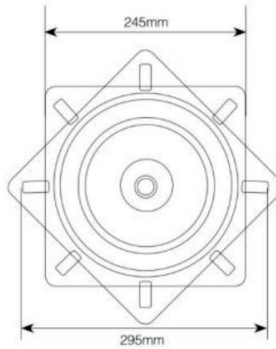

材质厚度
2.0mm/2.5mm/3.0mm
尺寸/Size:250x250mm转盘

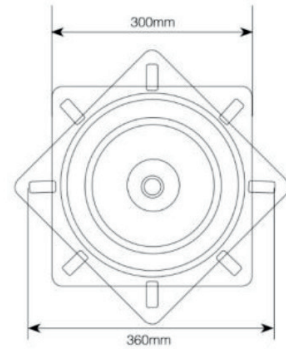

材质厚度:2.5/3.0mm
尺寸/Size:300x300mm转盘

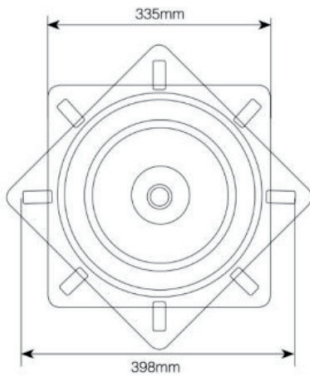

材质厚度: 2.5/3.0mm
尺寸/Size:330x330mm转盘



C-737回力转盘
尺寸/Size:200x200mm



C-736大转盘 (厚/薄)

Sofa Recliner Mechanism



EM INDUSTRIAL SUPPLIES

Recliner & Sofa Mechanism Spares Supplier



C-4311单人位/Single



C-4311分体二人位/Two seats separated



C-4311分体三人位/Three seats separated

木架效果图



C-4311 连体二人位/Three Seats Combined



W03 连体三人位角铁

W02 连体二人位角铁
Connection accessories



W04 宽边分体角铁

W01 分体角铁



Sofa Recliner Mechanism



EM INDUSTRIAL SUPPLIES

Recliner & Sofa Mechanism Spares Supplier

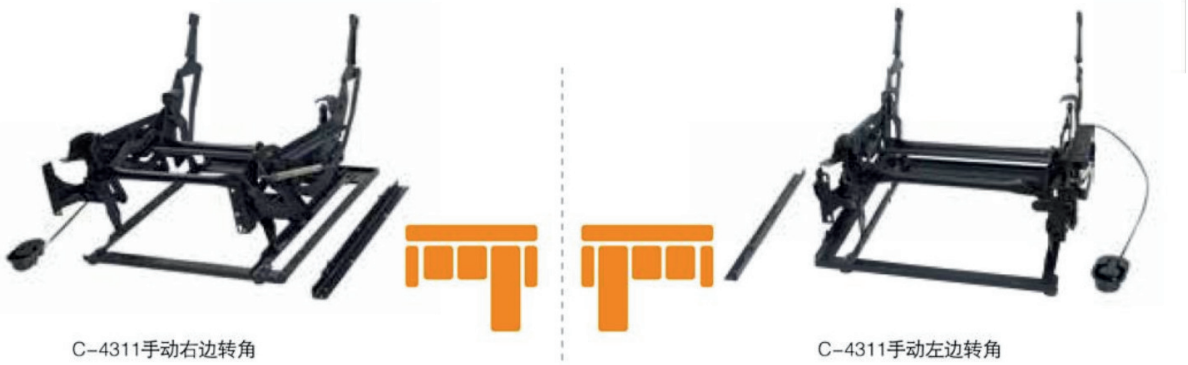

C-4311手动右边转角

C-4311手动左边转角



C-4311 电动架
Electrical recliner mechanism



规格 Specification	*A*尺寸(Size)两扶手距离 *A*Size Between the arm mounting dimensions	
	MM	IN
-0	450	18
-1	475	19
-2	500	20
-3	525	21
-4	550	22
-5	575	23
-6	600	24
-7	625	25
-8	650	26
-9	675	27
-10	700	28



C-4311电动右边转角

C-4311电动左边转角

Sofa Recliner Mechanism



EM INDUSTRIAL SUPPLIES

Recliner & Sofa Mechanism Spares Supplier



C-4311 电动架/Electrical recliner mechanism



C-396 电动架/Electrical recliner mechanism



C-K1手控



C-K9手控



C-K6A手控



C-k6手控



L15 带USB手控



L14 带USB发光手控



L12 带USB手控



L12 手控



L2铝合金手控



L3铝合金手控



L6



L1铝合金手控



L17 触摸开关



L4铝合金发光手控



L10 带USB发光手控



L11 带USB手控



L7带USB发光手控



L5带USB发光手控



L53 带USB发光手控



L9A一控二手控



L9B一控二手控



L8



L13一控二手控

产品规格表
(369/396) Product specifications

尺寸 Specification	尺寸(Size)两扶手距离 Between the arm mounting dimensions	
	MM	IN
-1	594	23 3/8"
-2	616	24 1/4"
-3	641	25 1/4"
-4	514	20 1/4"
-4.5	535	21 1/4"
-5	565	22 1/4"
-6	578	22 3/4"
-7	708	27 7/8"
-8	730	28 3/4"
-9	791	31 1/8"



C-369 手动架/Manual recliner mechanism



C-396 电动架/Electrical recliner mechanism

Sofa Recliner Mechanism



EM INDUSTRIAL SUPPLIES

Recliner & Sofa Mechanism Spares Supplier



C-4311可转



C-3368电动架



C-339 电动头枕



3368+339电动头枕



C-036 遥带转底架
Glider base with swivel

包装尺寸: 81x56x51cm
包装数量: 2Pcs/ctn



C-340 头枕



小号储物盒



大号储物盒



C-036 遥带转底架
Glider base with swivel



成品效果图



C-037 单遥上部分遥架/Glider base
包装尺寸: 85x56x46cm

Sofa Recliner Mechanism



EM INDUSTRIAL SUPPLIES

Recliner & Sofa Mechanism Spares Supplier



C-4181 遥带转
Glider recliner with swivel

铁架尺寸: 85x56x46cm 2Pcs/ctn
转盘尺寸: 62x62x21cm 2Pcs/ctn



C-4381 电动遥带转
Glider recliner with swivel



C-4181 单遥
Glider recliner mechanism

包装尺寸: 85x56x51cm
包装数量: 2Pcs/ctn



C-418E 单遥连体二人位
Two Seats Combined Glider recliner



C-4381 E 单摇



C-4381 E 摇带转



C-4311 中间单位/The middle seat



C-4311 手柄单位/Manual recliner mechanism

Sofa Recliner Mechanism



EM INDUSTRIAL SUPPLIES

Recliner & Sofa Mechanism Spares Supplier



C-4302 单人位



C-5302 电动架



C-4311电动架落地款右转角



L型加厚底板铁 70/75cm



C-4311电动架落地款左转角



C-3380手动架



C-3380电动架



A047 手动架



A048 电动架



Sofa Recliner Mechanism



EM INDUSTRIAL SUPPLIES

Recliner & Sofa Mechanism Spares Supplier



C-8326 简易架/Simple recliner mechanism



C-8362D(手/电动)



尺寸: ϕ 550mm
A046休闲架



C-558 电动升降架



C-548 电动升降架(单电机)
Electric casual chair stand



Sofa Recliner Mechanism



EM INDUSTRIAL SUPPLIES

Recliner & Sofa Mechanism Spares Supplier



C-206 简易架/Simple recliner mechanism



C-8541E(手/电动)



C-8550 简易架/Simple recliner mechanism



C-207 简易架(8550简易架加底框)
Simple recliner mechanism with base



C-8542 简易架/Simple recliner mechanism



C-8053 简易架/Simple recliner mechanism



C-216 儿童椅架
Recliner for children Chair

可选配 J-03KD 插件



C-8541F 简易架/Simple recliner mechanism

Sofa Recliner Mechanism



EM INDUSTRIAL SUPPLIES

Recliner & Sofa Mechanism Spares Supplier

Size A	
Inches	mm
18.40	467.4
20.40	518.2
24.40	621.2
29.15	740.4

Sofa Recliner Mechanism



EM INDUSTRIAL SUPPLIES

Recliner & Sofa Mechanism Spares Supplier



J-03 KD 背插件
Seat back cushion plug-in hinge



J-01 KD 背插件
Seat back cushion plug-in hinge



C-57 茶几铰



C-54 茶几铰
Tea table stand



C-55 茶几铰
Tea table stand



C-56 茶几铰
Side table stand



F-50 茶几铰



F-29 沙发铰



F-16 手柄
Plastic handle



B-06 保护片/Protective Plate



开关电源盒



4311 脚垫



E-2 中位拉手线
The middle handle



F-13 喷塑合金拉手线
Alloy Zinc Electrophores



F-12 镀铬合金拉手线
Alloy Zinc Chromate



F-14 黑色塑胶拉手线
ABS Plastic

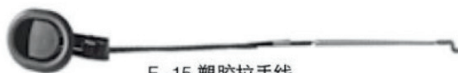

F-15 塑胶拉手线

Sofa Recliner Mechanism



EM INDUSTRIAL SUPPLIES

Recliner & Sofa Mechanism Spares Supplier



C-535 矮杯
Plastic Cup holder
Size: ϕ 85xH35mm



C-536 茶几杯
Plastic Cup holder
Size: ϕ 85xH60mm



C-539 铝杯
Aluminum Cup holder
Size: ϕ 80xH65mm



C-531 电镀杯
Chrome Plating Cup holder
Size: ϕ 85xH60mm



C-534 矮铝杯
Size: ϕ 80xH35mm



C-538 黑铝杯
Size: ϕ 80xH65mm



C-537 铝合金彩杯
Size: ϕ 80xH65mm



C-532 高杯
Plastic Cup holder
Size: ϕ 85xH100mm



C-533 螺纹茶几杯
Size: ϕ 75xH56mm



C-543 荧光杯
Size: 125x90x65mm



C-545 烫银杯
Size: 110x92x85mm



C-547 不锈钢杯(拉丝/亮光)
Size: 111x89x58mm



C-542 不锈钢杯(拉丝/亮光)
Size: 102x90x55mm



C-541 不锈钢杯(拉丝/亮光)
Size: 105x85x55mm



D01 插片



D02 插片



D03 插片



218A 连接件



218B 连接件



C-215 连接插片
Sofa Connection buckle



1# 扶手角码
Size: 138x53mm



2# 扶手角码
Size: 90x33mm



C-235 床用挂铁



J-05 带钉带槽连接件

Recliner Sofa Bed Series



EM INDUSTRIAL SUPPLIES

Recliner & Sofa Mechanism Spares Supplier



C-031 抽屉铰/Sofa bed push-pull hinge



C-031和C-032的木架组合图



C-032 床箱铰
Sofa bed storage hinges/Active Link parts



C-031A 抽屉床架



C-031D 抽屉床架



C-031E 抽屉床架

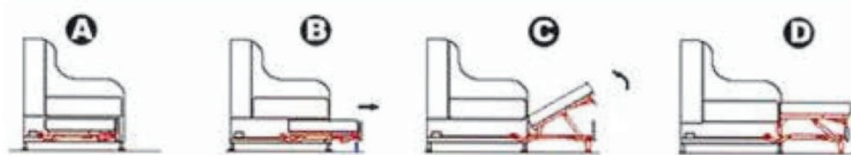

F-02 小号轮

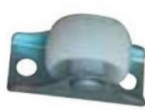

F-04 边轮



F-06 大号轮



F-11 三节导轨



U形定制脚



F-03 边轮



3# 角码



三孔边脚

Recliner Sofa Bed Series



EM INDUSTRIAL SUPPLIES

Recliner & Sofa Mechanism Spares Supplier



C-034 抽屉铰



C-035 抽屉铰



C-035A 抽屉床架



C-035C 抽拉床架套料



C-416 抽拉床套料



Q-312 铰链

Recliner Sofa Bed Series



EM INDUSTRIAL SUPPLIES

Recliner & Sofa Mechanism Spares Supplier

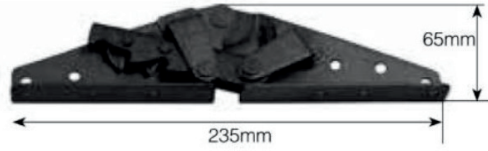

金色 黑色

C-11小型沙发铰

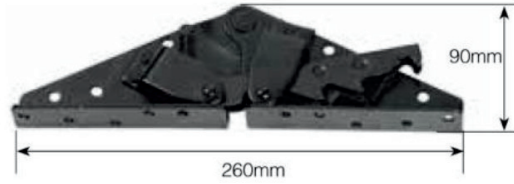

金色 黑色

C-12-2中型沙发铰
Small Double-use hinge

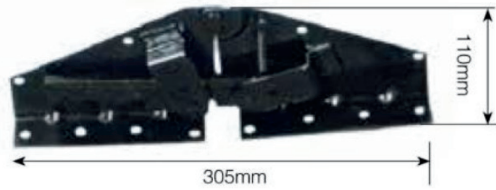

金色 黑色

C-10加厚大铰(可镀锌)
Sofa Bed Mechanism



C-133鸡比较

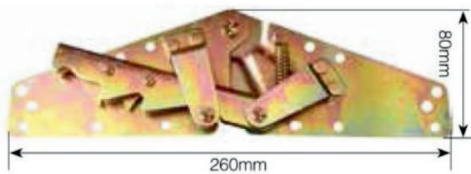

C-131金色无边铰



F-33折叠脚(可订做高度)



C-132沙发床铰



Recliner Sofa Bed Series



EM INDUSTRIAL SUPPLIES

Recliner & Sofa Mechanism Spares Supplier



C-612 电动座位滑动架



C-612 手动座位滑动架



C-619 沙发座位滑道
Seat ratchet hinge



C-611 沙发座位滑动架
Seat ratchet hinge



C-611 带限位沙发座位滑动架
Seat ratchet hinge



C-033 床箱铰
Sofa bed storage hinge



C-039 床箱铰
Sofa bed storage hinge



C-418 沙发转盘

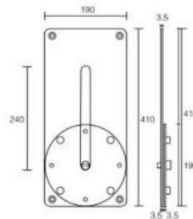

Recliner Sofa Bed Series



EM INDUSTRIAL SUPPLIES

Recliner & Sofa Mechanism Spares Supplier



C-134移动铰



C-134A移动铰



C-19千秋铰/Holmium hinge



C-19F千秋铰/Holmium hinge



C-19E千秋铰



C-19A摇臂铰

Recliner Sofa Bed Series



EM INDUSTRIAL SUPPLIES

Recliner & Sofa Mechanism Spares Supplier



C-43床用起动杆 0.6米/0.9米/1.5米
Multi-functional bed hinge



C-022床用起动架



C-023床用起动架



C-024床用起动架

规格:(Size)

0.5m	200N-600N
0.6m	200N-600N
0.9m	200N-1000N
1.1m	300N-1000N
1.2m	500N-1000N
1.5m	500N-500N-1200N
1.7m	500N-500N-1200N



C-89 水平床架



Recliner Sofa Bed Series



EM INDUSTRIAL SUPPLIES

Recliner & Sofa Mechanism Spares Supplier



C-73H 沙发床/ Sofa Folding bed Frame



C-73M 折叠床
Sofa Folding bed Frame
Size:78x74x34cm / 1Pcs/ctn

C-713 板条抽屜床

三折床系列



展开图

C-73A-1无板条三折床(宽1.0/1.4/1.5米可选)
Sofa sleeper mechanism

C-73A-2带板条三折床(宽1.0/1.4/1.5米可选)
3 Folds bed frame with wooden slats



三折床效果

三折床安装尺寸

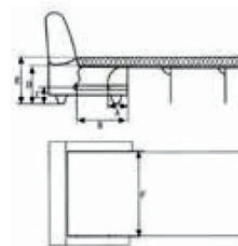

单位:mm 公差:±5

mm	A	B	C	D	E	F
900	115	615	145	400	450	1025
1000	115	615	145	400	450	1125
1200	115	615	145	400	450	1325
1400	115	615	145	400	450	1525

Recliner Sofa Bed Series



EM INDUSTRIAL SUPPLIES

Recliner & Sofa Mechanism Spares Supplier



C-73E 折床/Sofa Folding bed Frame

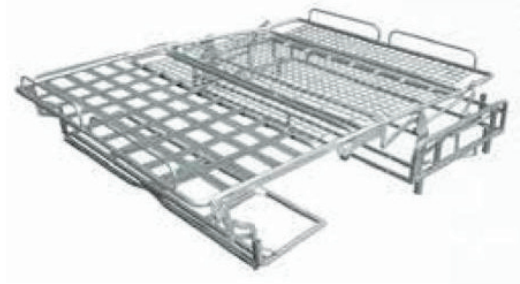

C-73F 折床/Sofa Folding bed Frame



C-723 抽拉床



C-73G 二折铁网床



Recliner Sofa Bed Series



EM INDUSTRIAL SUPPLIES

Recliner & Sofa Mechanism Spares Supplier



C-73B二折沙发床/2 Folds bed

安装尺寸:

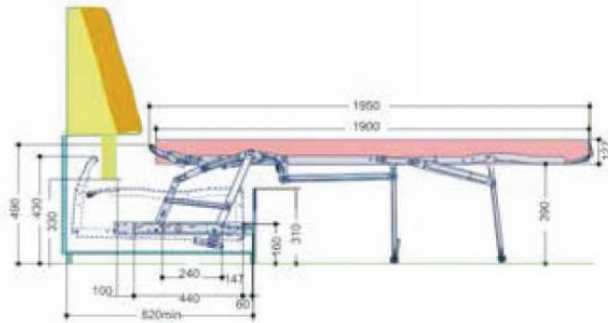
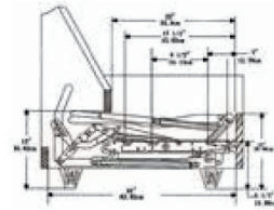

二折床效果

Code	Mounting Width(Inches)	Side plates	Mattress Width(Inches)	Quantity per 40HQ	
				W/Mattress	W/O Mattress
2540	40	1016	32	328	394
2544	44	1117	36	292	364
2548	48	1219	40	236	330
2560	60	1524	52	216	282
2568	68	1727	60	182	234



C-73K二折铁网床



EM INDUSTRIAL SUPPLIES

Recliner & Sofa Mechanism Spares Supplier



M152

特性:

- 简洁时尚的金属外观, 彰显高雅尊贵品质;
- 支持iPhone / iPod / iPad播放及充电功能;
- 支持手机蓝牙播放, 摆脱“线”制;
- SD卡音乐播放;
- USB音乐播放及充电;
- 支持AUX, N;
- 功能转换方便, 每种功能工作时会有对应的LED显示。

Features:

- Simple and stylish metallic covering shows the high level quality.
- Music Play and recharge for iPhone / iPod / iPad.
- Support Bluetooth.
- SD card MP3 player.
- USB MP3 player/Recharger.
- AUX-IN.
- FUNCTION is easy to switch and operate.



M150 触摸音响



M155 触摸音响
for iphone/Android



M158 蓝牙音响



M159 蓝牙音响



M151 沙发音响



M157 触摸蓝牙音响



M302 一控二电源转换器
1. 可将29V电源转换为29V和12V输出。
2. 多种功能一个电源就能搞定



M156 蓄电池



特性
1. 一次性充满电约3.25小时
2. 充满电后可供单杆连续工作约50个来回
3. 配沙发外置充电



M301 沙发(旋转桌板)



D14 隐藏式USB插座



D15 方形双USB插座



D16 圆形双USB插座



EM INDUSTRIAL SUPPLIES

Recliner & Sofa Mechanism Spares Supplier

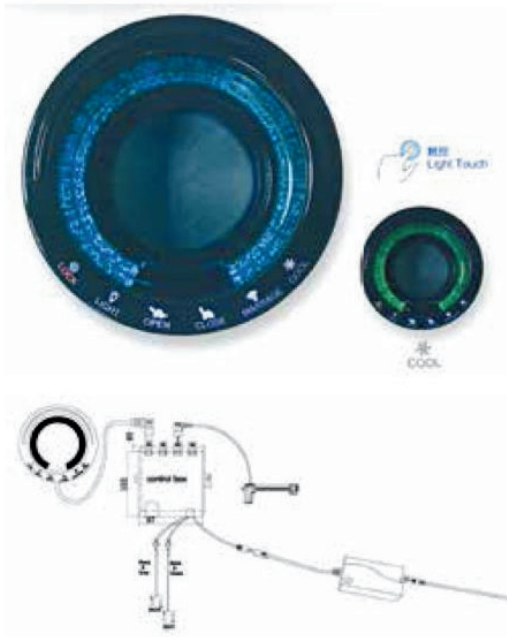

M153冷却杯

全球首发集照明，椅子升降，按摩，制冷功能于一体的功能杯座，全方位打造新概念的高级智能沙发，将休闲，舒适，科技，方便，洁净的理念展现得淋漓尽致。

- 防水
- 触控式按键避免集尘困扰
- 蓝色光感引领时尚前沿
- 制：令功效可以让你享受电影，球赛的过程中冰饮随手可得并保持低温。
- 控制其实可以很愉快

(可选:单位/双位/三位)

The first invention of combining illumination, auto recliner, massage, cooling functions in one cup holder, features in high-level intelligence to create new concepts sofa, people can enjoy comfortable, convenient and clean feeling thoroughly.

- Waterproof
- Light touch pad will not have the space dust problem
- Fashion style of blue light under the touch panel
- cool function can help you to easily enjoy ice drink and keep them cool during the whole movie or game period.
- Enjoy your control



●杯灯光CUP LIGHT



●脚灯可选Foot light is optional



Single Sofa Love Sofa Family Sofa

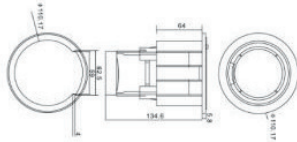

开孔尺寸/Hole Size

需另加皮料及海绵的厚度
Need to plus the thickness of leather and sponge

可适配4311电动架或396电动架



E-69 空气净化器(喇叭可选配)



E-68 阅读灯



E-68 USB插座(阅读灯选配)



振动按摩器/Massager



C-63(4-9位)

手控器示意图

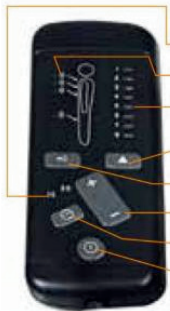

- 定时指示灯
- 按摩部位指示灯
- 按摩方式指示灯
- 按摩方式选择键
- 按摩部位选择键
- 按摩强度选择键
- 定时选择键
- 电源开关键

技术参数:

- 额定电压: DC12V
- 额定电流: 500—1200mA
- 额定功耗: 10W
- 额定工作时间: 15—30分钟
- 电源标准: 可做国标、欧标、美标、英标、澳标等世界各国电压标准
- 认证标准: CE、UL、TUV
- ROHS环保认证



C-63-B(4-10位)



C-63-E(4-10位)



C-63S 气囊按摩器



F-09弹力耐磨布



锈钢扶手拉簧



F-05抱枕按摩器



C-671 小头揉捏按摩器



EM INDUSTRIAL SUPPLIES

Recliner & Sofa Mechanism Spares Supplier



C-64揉捏按摩器



C-64-A背部+颈部+振动



C-64F背部揉捏+推杆

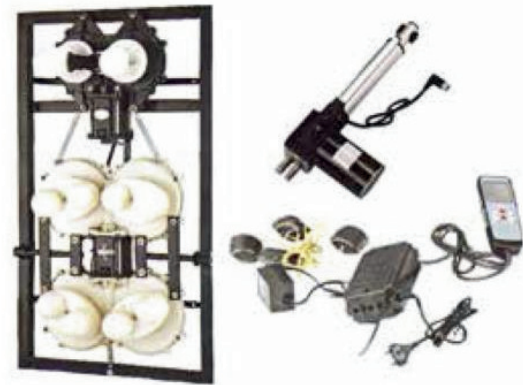

C-65-B背部+颈部+振动+推杆

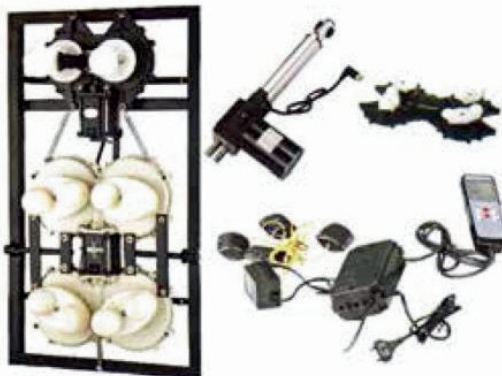

C-65-D背部+颈部+振动+推杆+小腿

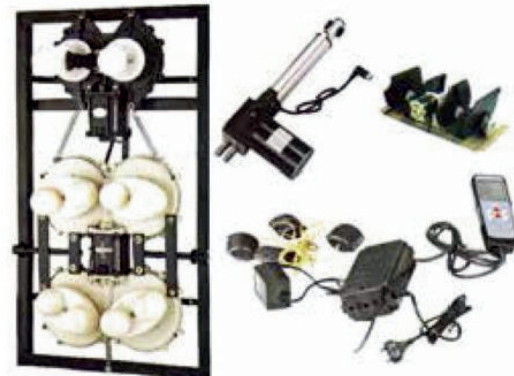

C-65-E背部+颈部+振动+推杆+夹

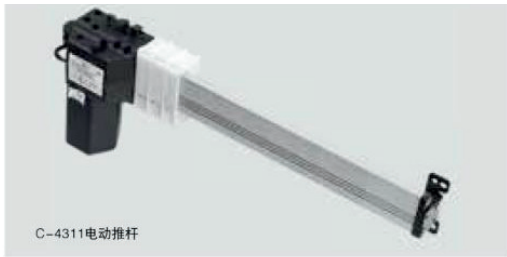

C-4311电动推杆

技术参数 Specifications

- 输入电压 Input: 24VDC
- 最大负载 Load Capacity: 6000/1000N
- 速度 Speed: 4mm/s(6000N) 18mm(1000N)
- 标准行程 Standard stroke: 100、150、200、250、300、350、400(可选Option)
- 最小安装距 Min.Install dimension: 400mm(可指定 Option)
- 行程开关 Limit switches: 内置Inner
- 使用频率 Type of duty: S2-10min
- 环境温度 OperatiOn Temperature: -26°C-65°C
- 安全认证 Certification: CE/EMC+LVD

电流与负载关系图 Current vs load

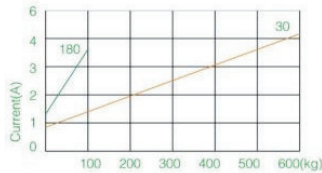

速度与负载关系图 Speed vs load

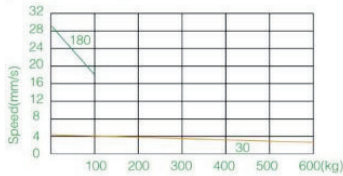

安装尺寸图

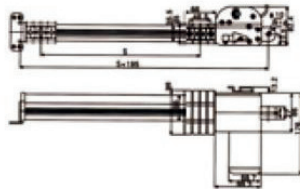

C-4311 电动推杆

行程(S) Stroke	推力 Thrust	速度 Speed	最小安装距 min Dimension	尾部接头方式
C-4311 330	4000N	8mm/s	525	H
(30-400可指定)	4000N	(4-18mm/s)	195+行程	



C-815电动推杆

技术参数 Specifications

- 输入电压 Input: 24VDC
- 最大负载 Load Capacity: 750N
- 最大速度 Speed: 50mm
- 标准行程 Standard stroke: 100、150、200、250、300、350、400(可选Option)
- 最小安装距 Min.Install dimension: S+110mm(可指定 Option)
- 行程开关 Limit switches: 内置Inner
- 使用频率 Type of duty: S2-10min
- 环境温度 OperatiOn Temperature: -26°C-65°C

电流与负载关系图 Current vs load

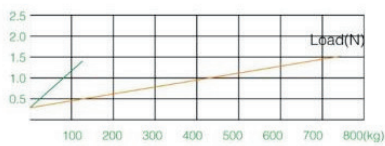

速度与负载关系图 Speed vs load

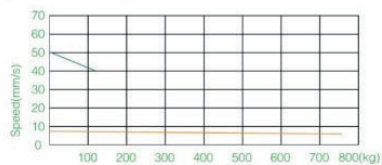

安装尺寸图

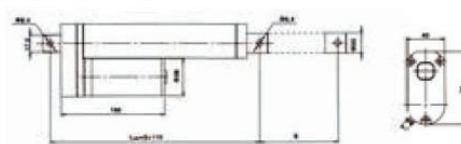

C-815 电动推杆

行程(S) Stroke	推力 Thrust	速度 Speed	最小安装距 min Dimension	尾部接头方式
C-815 100	700N	15mm/s	21	H or v
S ≤ 50	500N	(10-50mm/s)	L _{min} =160	
S = (50-400)			L _{min} =110+S	



EM INDUSTRIAL SUPPLIES

Recliner & Sofa Mechanism Spares Supplier



C-803电动推杆

技术参数 Specifications

- 输入电压 Input: 24VDC
- 最大负载 Load Capacity: 6000/2000N
- 速度 Speed: 3mm/s(8000N) 4mm(2000N)
- 标准行程 Standard stroke: 100、150、200、250、300、350、400(可选Option)
- 最小安装距 Min.Install dimension: S+175mm(可指定 Option)
- 行程开关 Limit switches: 内置Inner
- 使用频率 Type of duty: S2-10min
- 环境温度 OperatiOn Temperature: -26°C~65°C
- 防护等级 Protection Class: IP 54
- 安全认证 Certification: CE/EMC+LVD
- 颜色 Colour: 黑色或乳白色 Black or Gray

电流与负载关系图 Current vs load

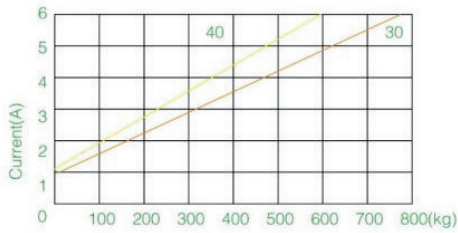

速度与负载关系图 Speed vs load

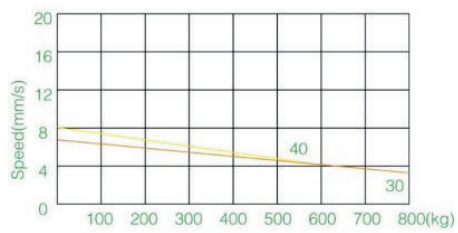

应用效果图



安装尺寸图 Installation Dimension

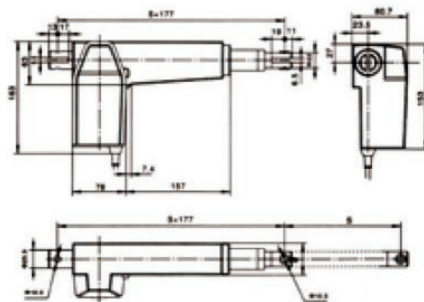

尾端接头

H型



V型



顶端接头

带胶套开叉钢头



带胶套实心钢头



C-803电动推杆

	行程(S) Stroke	推力 Thrust	速度 Speed	最小安装距 min Dimension	尾部接头方式
C-803	150	6000N	4mm/s	325	H or V
	30-150	6000N 4000N	(4-18mm/s)	325	
	150-400			175+S	



EM INDUSTRIAL SUPPLIES

Recliner & Sofa Mechanism Spares Supplier

开关电源/Power adaptor



A031

技术参数 Specifications

- 输入电压及频率 The Input Voltage and Frequency: 100—240VAC47—63Hz 1.5AMAX
- 输出功率 The output power: 29VDC2A 58W
- 最大输出电流 The maximum current: 4A PEKE 8A
- 整机效率 Efficiency: $\geq 85\%$
- 纹波Vp-p Vp-p Ripple: $\leq 400\text{mV}$
- 空载功耗: $\leq 0.5\text{W}$ 符合能源之星IV标准
Standby Power: $\leq 0.5\text{W}$ Meet the standard of ENERGY STAR IV.
(The latest standards of California)
- 负载及线性调整率 Output Voltage Tolerance: $\pm 5\%$
- 保护功能 All-round protection; OVP OCP OPP MAX 8A
- 短路保护功能: 输出短路时不损坏机器, 短路解除后自动恢复
Short Circuit Protection: No damage to the machine when it is short circuit of output; The power supply shall be self-recovered when short circuit is removed.
- 工作温度 Operating Temperature: -20°C — $+50^{\circ}\text{C}$
- 安全认证: GS CE UL PSE CE+LVD FCC符合ROHS
Security Certification: GSCE UL PSE CE+LVD FCC meet the Rolls requirement

变压器/Transformer box



A015

技术参数 Specifications

- 输入电压 Input Voltage: 110 or 230 VAC
- 输出功率 Output power: 24VDC, 50VA
- 使用频率 Duty Cycle: 10%, Max. 2 min on/18 min off
- 能连接 1—3台电动推杆及一只手控器或脚踏开关
Can connect 1—3 linear actuator and 1 handset or foot-switch
- 内置过载保护装置 Inner overload Protection
- 颜色 Colour: 黑色或灰白 Black or gray



A025

技术参数 Specifications

- 输入电压 Input Voltage: 110 or 230 VAC
- 输出功率 Output power: 24VDC, 86VA
- 使用频率 Duty Cycle: 10%, Max. 2 min on/18 min off
- 能连接 1—5台电动推杆及一只手控器或脚踏开关
Can connect 1—5 linear actuator and 1 handset or foot-switch
- 内置过载保护装置 Inner overload Protection
- 颜色 Colour: 黑色或灰白 Black or gray



EM INDUSTRIAL SUPPLIES

Recliner & Sofa Mechanism Spares Supplier

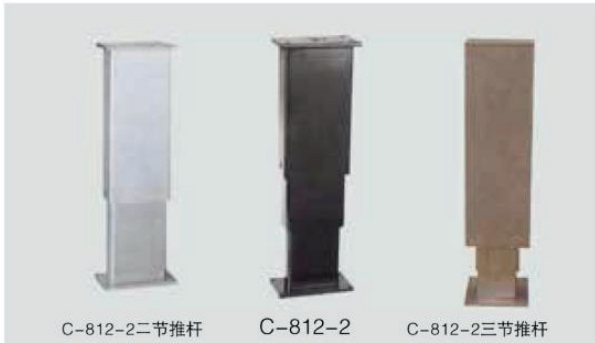

C-812-2二节推杆 C-812-2 C-812-2三节推杆

技术参数 Specifications

- 输入电压 Input: 24VDC
- 最大负载 Load Capacity: 4000/2000N
- 最大速度 Max .Speed: 3mm/s(400N) 13mm(2000N)
- 标准行程 Standard stroke: 100、150、200、250、300、350、400(可选Option)
- 行程开关 Limit switches: 内置Inner
- 使用频率 Duty Cycle: 10%,Max.2 min on/18min off
- 环境温度 OperatiOn Temperature: -26°C~65°C

电流与负载关系图 Current vs load

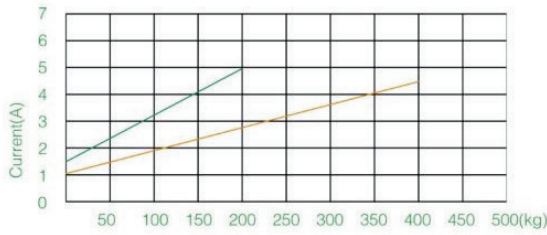

速度与负载关系图 Speed vs load

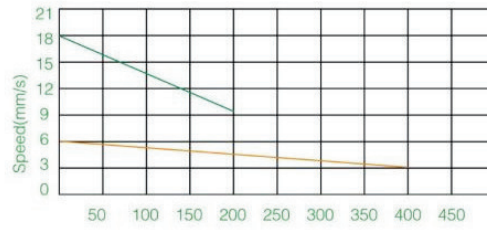

C-812-3

电流与负载关系图 Current vs load

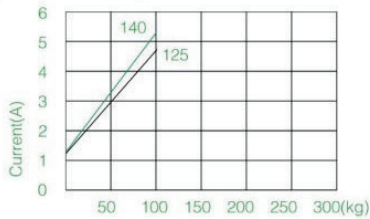

速度与负载关系图 Speed vs load

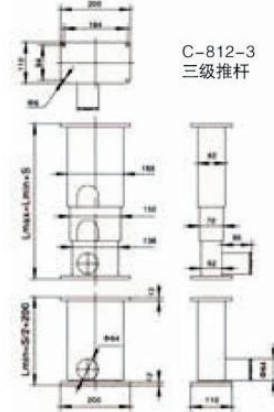
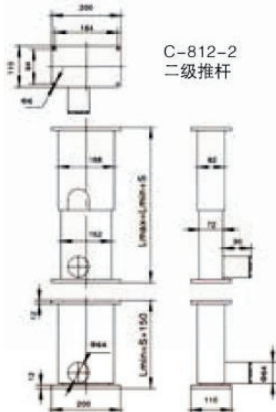
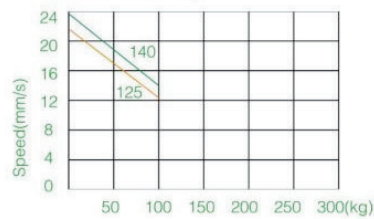



EM INDUSTRIAL SUPPLIES

Recliner & Sofa Mechanism Spares Supplier



C-4311-2电机



C-4311-1电机



C-4311-3电机(触摸手柄)



C-089 一拖四电机

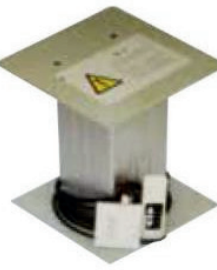

C-088 电动升降立柱



C-087 气动升降立柱

插头种类/Plug Type



C-808 OKIN / (国产)双驱动马达



英标



欧标直插



欧标弯插



澳标



国标



美标

手控种类/Manual type



C-K1手控



C-K9手控



C-K6A手控



C-K6手控



L-12 带USB 手控



L-14 带USB发光手控



L-1 铝合金手控



C-K8A 一拖一手控



C-K8A一拖二手控



C-K8B一拖三手控



C-K5A手控



C-K5B一拖二手控



C-K4手控



L18 无线手控



电动推杆组合搭配



C-802B—拖一—铝电机



C-8022—拖二—铝电机



C-8023—拖一—触摸电机



C-802A—拖一—铝电机



C-803A—拖一—钢电机



C-803B—拖二—白色钢电机



C-803A—拖三—电机



C-803C—拖三—钢电机



C-815电机



C-805—拖一—无线遥控电机



C-805—拖一—电机



C-805—拖二—电机



EM INDUSTRIAL SUPPLIES

Recliner & Sofa Mechanism Spares Supplier



C-31角调气杆
Locking gas spring

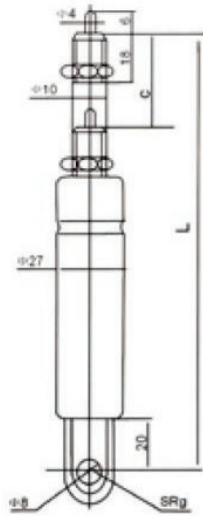

型号编码

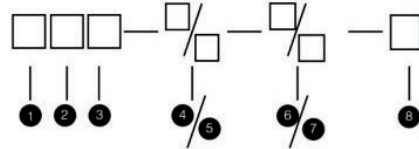

- ①管端卡(Q型 H型、大U、中U、小U)等类型
- ②杆端卡(大U、蝴蝶头、压铸接头)等
- ⑧锁紧方式(S: 弹性锁死 H: 硬性锁死)
- ④杆径 φ 10
- ⑤管径 φ 27
- ⑥C行程(30-500mm)
- ⑦L安装尺寸
- ⑧压力F1(100-1000N)

产品说明 Product description

可控气弹簧(角调气杆)主要用于椅背角度调节,它具有无级调程,无异响,操作方便的优点。可分为弹性锁死与硬性锁死两种,可视客户要求而定。本产品具有防渗油功能,内摩擦力小,使用寿命长的特点,疲劳测试可达五万次无不良状况。广泛应用于汽车座椅、可躺沙发、双功能班椅、美容床椅、按摩椅等。尺寸和力度可根据客户要求订做。

Lockable gas spring is mainly used to adjust angle for lazyback, without abnormal sound and easy to operation. Which can be divided into elastic locking and rigid locking two kinds, but according to customer's requirements. With the function of oil leakage prevention, anelasticity small and long service life etc salient feature, fatigue test more than fifty thousand times without any adverse conditions. Widely used in automotive seat, reclining sofa, difunction office chair, hairdressing chair/bed, massage chair etc. Size and strength according to your special need.

应用实例



户外休闲椅



F-31F
卡簧型角调气杆



升降茶几/餐台



EM INDUSTRIAL SUPPLIES

Recliner & Sofa Mechanism Spares Supplier

行程、力度可订做



C-31E



C-31A 角调气杆



C-31D 角调气杆



C-31C



C-31B



C-37A-1 电镀锌合金开关(卡头型)



C-37B 黑色锌合金开关(卡头型)



C-37-2 电镀锌合金开关(螺丝型)



C-37B-1 黑色锌合金开关(螺丝型)



C-37C-2 黑色ABS塑胶开关



C-37C-1 电镀 ABS塑胶开关



C-37-3 电镀锌合金开关



C-41-7 铝合金按钮头



C-999 开关
ABS塑胶/合金



C-37-5
一控二塑料开关



一控二开关配线



C-42-5 新款连体按钮



C-42-4 直手柄配大U码





EM INDUSTRIAL SUPPLIES

Recliner & Sofa Mechanism Spares Supplier



38A-3



38A-4



8A-6 底盘手柄升降拉线



C-430 弯手柄配线



C-38D-1 底盘手柄升降拉线



3-D



4-D



C-42-6 电镀按钮配线



5-D



E-2



8-D



C-406 双控手柄配拉线



C-42-4直手柄



C-32



C-33



C-30E



C-30B



C-30A



C-30C



C-30D
小蝴蝶角码



C-30K
大蝴蝶角码



C-34C



C-34A 蝴蝶头



C-30F



C-30M新大U



C-30N 新小U



C-30H



C-30G十字电动角码



C-33A



C-33-E



C-33H合金压铸头



C-33F合金压铸头



C-32E



C-32F 焊铁片弯形角码



φ 10mm平面轴承

φ 8mm插销

φ 8mm非标轴承



EM INDUSTRIAL SUPPLIES



C-148 单手柄腰靠调节器

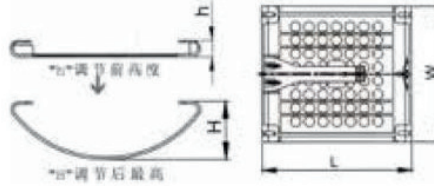

C-147 双手柄腰靠调节器

背靠板类型表			
L(mm)	W(mm)	h(mm)	H(mm)
160	130	12	44
160	170	12	44
220	220	35	65



牙科椅



C-31-1



C-31-3



C-31-2双控



C-31-4



C-31-5



F46合页



C-29
有手柄座位滑轨



C-30
无手柄座位滑轨



C-29E双弯有手柄



EM INDUSTRIAL SUPPLIES

Recliner & Sofa Mechanism Spares Supplier



C-63-5单气杆配件



C-63-2单气杆配件



C-63-1A单气杆配件



C-63-3A单气杆配件



C-63-8 四方盒手柄



C-63-7按钮可躺配件



C-60 班椅倾仰器



效果图





Compressing Gas Spring EM INDUSTRIAL SUPPLIES

Recliner & Sofa Mechanism Spares Supplier

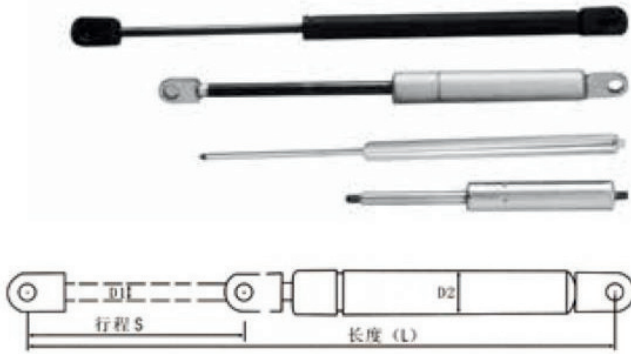

应用于礼堂椅



C-305A 撑杆

C-41 撑杆(黑/白色)

C-41E 碳化撑杆

C-39 撑杆

C-41C 带锁定撑杆



C-087 气动升降立柱



C-31F 卡簧型角调

C-41K 双头撑杆

C-41 撑杆



Sauna, Pedicure Sofa Accessories



EM INDUSTRIAL SUPPLIES

Recliner & Sofa Mechanism Spares Supplier



Sauna, Pedicure Sofa Accessories



EM INDUSTRIAL SUPPLIES

Recliner & Sofa Mechanism Spares Supplier



C-82-A电动架配活动扶手架



C-82-A效果图



X-8828 沙发



C-82-H 上半部分扶手活动架



C-82-D 电动扶手活动架



C-82-E 电动扶手活动架



C-82-F 上半部分扶手活动架



C-883D电动床架



C-883电动床架



C-107电动床架



X-8088沙发床



EM INDUSTRIAL SUPPLIES

Recliner & Sofa Mechanism Spares Supplier



C-103 一控二电机电动床



C-102双驱动马达电动床



德国okin电机

选配

国产双驱动电机



C-725 电动扶手活动架



C-726 电动扶手活动架



C-727 电动床架



C-728 电动床架



效果图



C-729 可升降电动床架





EM INDUSTRIAL SUPPLIES

Recliner & Sofa Mechanism Spares Supplier



C-82-K 电动扶手活动架



C-82-G 上半部分扶手活动架



C-604 铝合金臂电视支架



C-605电视支架



C-613不锈钢双位电视支架



C-601B单杆不锈钢电视支架



两头均可装(不分左右)

C-601豪华不锈钢电视支架(浸黑磨砂漆/仿古铜)



C-602豪华不锈钢电视支架(浸黑磨砂漆/仿古铜)



C-603B带键盘电视支架(浸黑磨砂漆/仿古铜)



C-606A 铝合金臂电视支架

C-606B 电视支架

Tea Table Series



EM INDUSTRIAL SUPPLIES

Recliner & Sofa Mechanism Spares Supplier



CJ-01



CJ-02



CJ-03



CJ-04



CJ-05



CJ-06

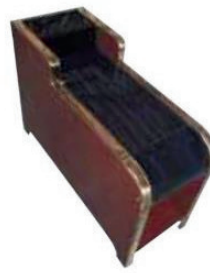

CJ-07



CJ-08



CP-01足浴盆
Size:560x600x300mm



CP-02足浴盆
Size:600x480x260mm



CP-03足浴盆
Size:560x460x320mm



Sofa Base



EM INDUSTRIAL SUPPLIES

Recliner & Sofa Mechanism Spares Supplier



C-913A

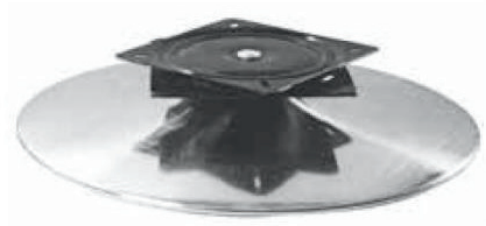

C-915A



C-916A Stainless steel



C-912A



C-95-1



C-95-6

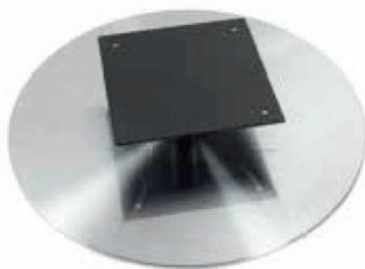

C-914A / Stainless steel



Sofa Base



EM INDUSTRIAL SUPPLIES

Recliner & Sofa Mechanism Spares Supplier



C-91电镀锥形叭盘 / Polished chrome
规格: ϕ 380/400/430/450/500/550/600/680



C-916A不锈钢底盘 / Stainless steel
规格: ϕ 540/580



C-93电镀球面叭盘 / Polished chrome
规格: ϕ 380/450/580



C-94电镀拉丝叭盘
Nickel wire drawing



C-95H 型轴承架



C-95Y 型轴承架



C-95F 轧型板轴承架



C-96H 型轴承架



C-96F 轧型板轴承架



C-915 A 转轴



Plastic Sofa Leg



EM INDUSTRIAL SUPPLIES

Recliner & Sofa Mechanism Spares Supplier

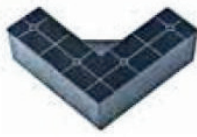

S-1555-1
Size:150x50x50mm



S-1855
Size:180x50x50mm



S-2155
Size:211x50x50mm

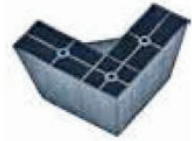

S-10355
Size:100x35x50mm



S-18565
Size:180x50x65mm



S-18865
Size:180x80x65mm



S-1555-2
Size:150x50x52mm



S-1694
Size:165x88x42mm



S-82821
Size:82x82x100mm



S-9195
Size:91x91x90mm



S-92175
Size:92x71x50mm



S-16083 83x83x160mm
S-20083 83x83x200mm



S-5125A
Size:125x125x50mm



S-5125B
Size:125x125x50mmxM8



S-8981B
Size:98x98x80mm



S-8981A
Size:98x98x80mm



S-74610
Size:74x60mmxM10



S-8282F
Size:75x75x60mm



S-20865A
Size:205x80x46mm



S-20865B
Size:205x80x46mm

Stainless Steel Sofa Leg



EM INDUSTRIAL SUPPLIES

Recliner & Sofa Mechanism Spares Supplier



C-002



C-002A



C-008



C-008A



C-006

φ 60管
高6cm
8cm
10cm
12cm



C-007

φ 48管
高5cm
6cm
8cm
10cm
12cm



C-015套筒



C-003



C-012



C-004



C-009



C-882



C-014



C-016



C-881



C-88-7

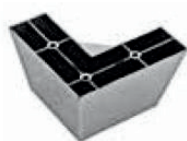

S-1035 电镀色
S ise:100x35x50mm



S-8282E 电镀色
S ise:75x75x60mm



S-1935
S ise:190x35x50mm

EM GROUP | SOUTH AFRICA | UNITED KINGDOM | ZIMBABWE



EM INDUSTRIAL SUPPLIES



OUR BRANCHES

64 Shetland Drive
Queens Park
Bulawayo
Zimbabwe

2 Premier Place
Industrial Park
Durban, KZN
South Africa

Agent Kumen Naidoo
163 North End Road West
Kensington London W14 9NH

Kumen@naidoolegal.co.uk

- @ emindustrial@telkomsa.net
- ☎ (+27) 074 918 1839
- 🌐 www.emgroupsa.co.za
- 🌐 www.emindustrialsupplies.com